

WEBB DECO Lighting Specification

灯具技术规格书

www.webbdecolighting.com

产品型号:

30.0851



基本参数:

- 材质: 灯体: ADC12压铸铝合金及6063挤压铝合金
反射器: 99.99%高纯度阳极氧化铝
出光玻璃: 4mm强化安全玻璃
密封圈: 耐老化耐水蒸气胶圈
紧固件: 304#不锈钢螺丝
- 表面处理: DuPont2层氟碳喷涂或环氧聚酯粉喷涂
- 输入电压: AC220V 50Hz;
- 光源寿命: ≥9000小时;
- 防护等级: IP65, I类绝缘,
- 引出线: 灯具出线1.1m, 3×1mm² 电缆线
- 环境温度: (-30℃, +45℃)
- 内箱尺寸:
- 外箱尺寸:

灯具尺寸图:

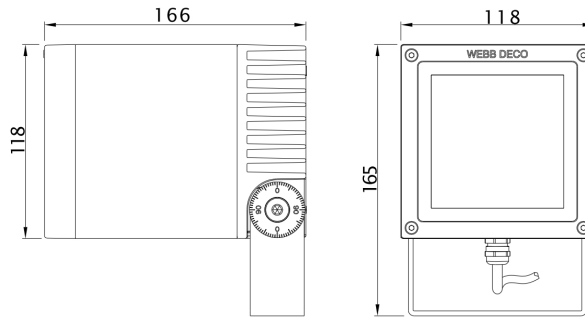

配光曲线图:

30.0851.20S

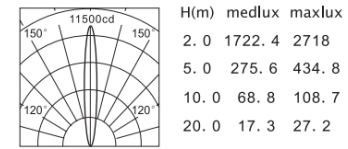

30.0852.20M

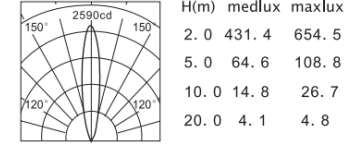

30.0851.20F32

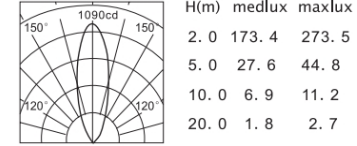

30.0851.20F45

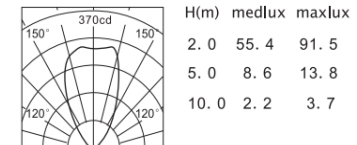

30.0851.20E

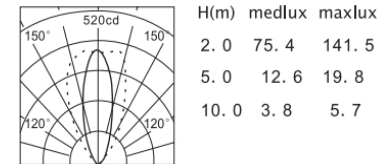

灯具技术规格书

www.webbdecolighting.com

产品型号说明:

产品型号	30	0851	*	*
灯具种类	模具型号	光源代码	光束角	
30: 投光灯		01: HIT 35W-G8.5 20: HIT 20W-G8.5	S: 窄角5° M: 中角15-25° F: 宽角30-60°	

灯具参数:

产品型号	光源	色温	灯头	光束角	光通量	灯具重量	包装毛重	图号
30.0851.20S	HIT 20W	3000K/4200K	G8.5	6°	2200lm	2.2kg		
30.0851.20M	HIT 20W	3000K/4200K	G8.5	22°	2200lm	2.2kg		
30.0851.20F32	HIT 20W	3000K/4200K	G8.5	32°	2200lm	2.2kg		
30.0851.20F45	HIT 20W	3000K/4200K	G8.5	45°	2200lm	2.2kg		
30.0851.20E	HIT 20W	3000K/4200K	G8.5	30x55°	2200lm	2.2kg		

可选配件:

光学玻璃



0851.303 0851.304

彩色镀膜玻璃



0851.305P 0851.305B 0851.305Ψ 0851.305Γ 0851.305Π

遮光罩

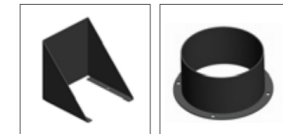

0851.205 0851.206